

VENTÜER TECHNICAL DATA SHEET

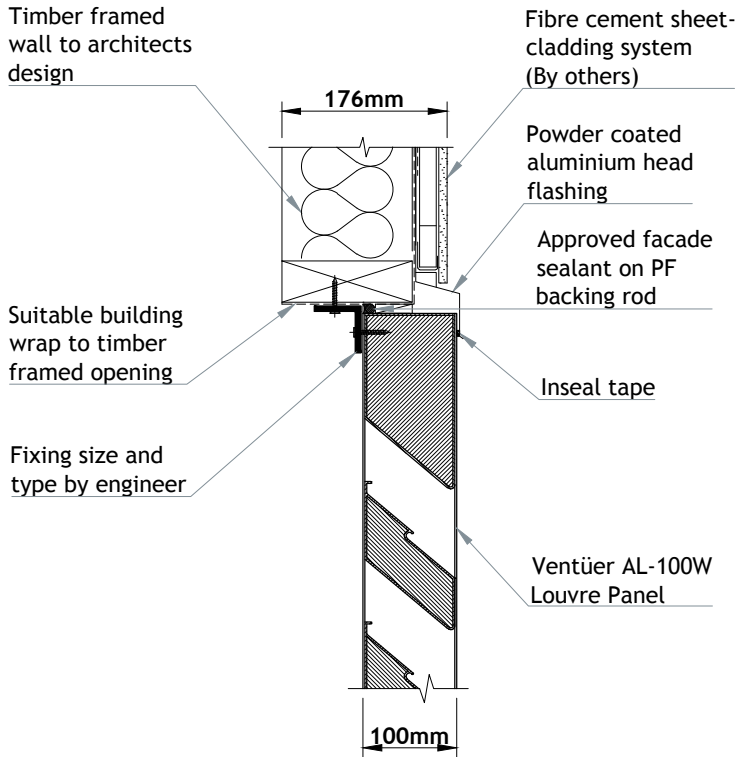

**AL-100W (CHANNEL FRAME)
HEAD DETAIL 01
SCALE 1 : 8**

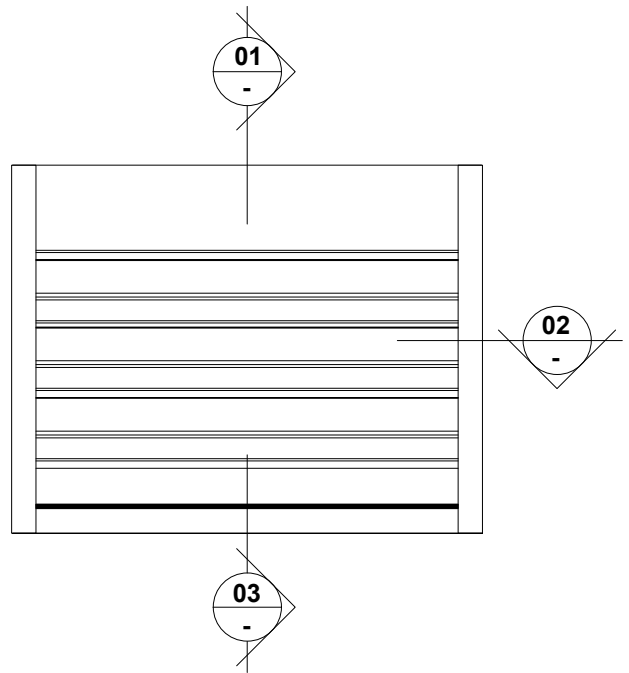

**AL-100W LOUVRE (CHANNEL FRAME)
SCALE - NTS**

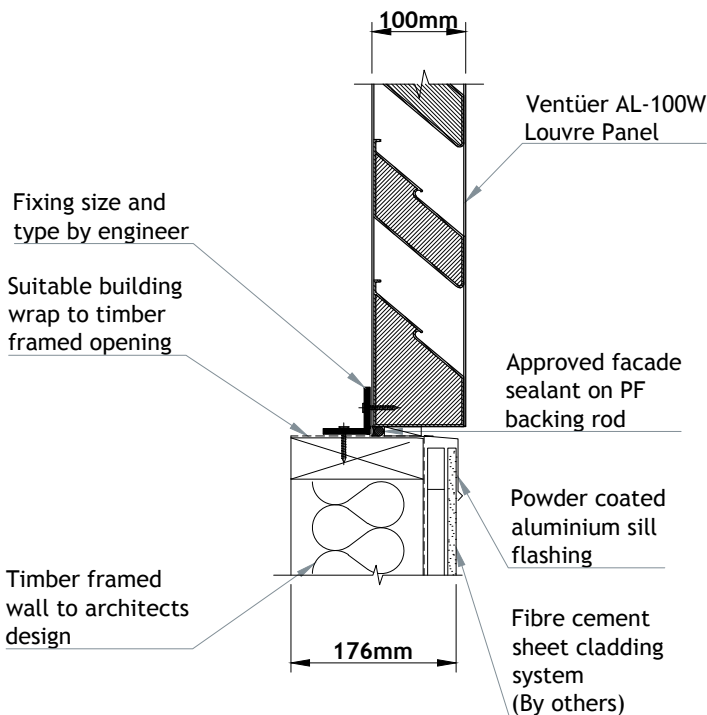

**AL-100W (CHANNEL FRAME)
SILL DETAIL 03
SCALE 1 : 8**

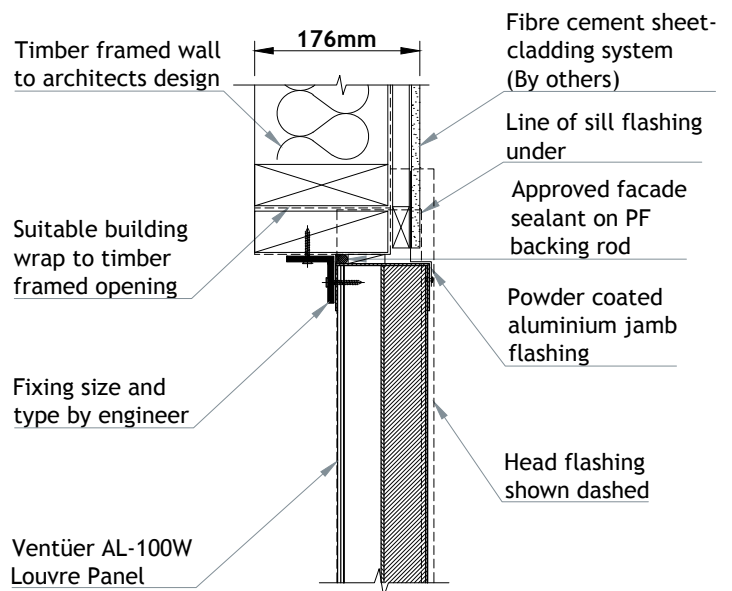

**AL-100W (CHANNEL FRAME)
JAMB DETAIL 02
SCALE 1 : 8**

ACOUSTIC LOUVRE
AL-100W
FIXING TO FIBRE CEMENT



VENTÜER
High-Performance Building Ventilation

P: +64 9 973 3616
W: ventuer.co.nz
© 2019 All rights reserved

Scale: 1 : 8
Date: 05/07/2019

AL-100W Ver.1