

# VENTÜER TECHNICAL DATA SHEET

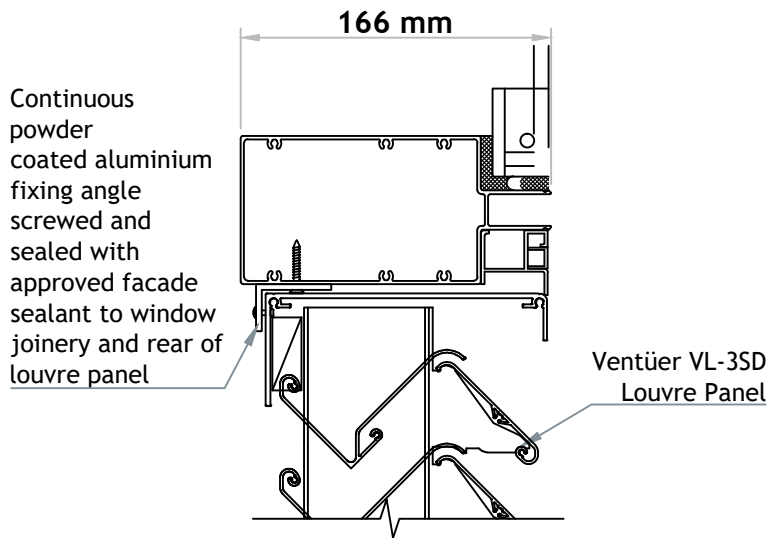

**VL-3SD (FLANGED FRAME)  
HEAD DETAIL 01  
SCALE 1 : 4**

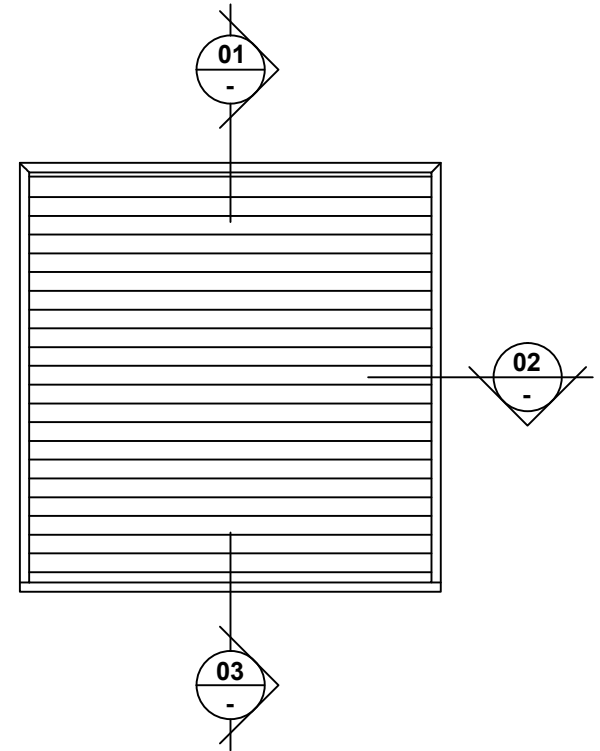

**VL-3SD LOUVRE (FLANGED FRAME)**

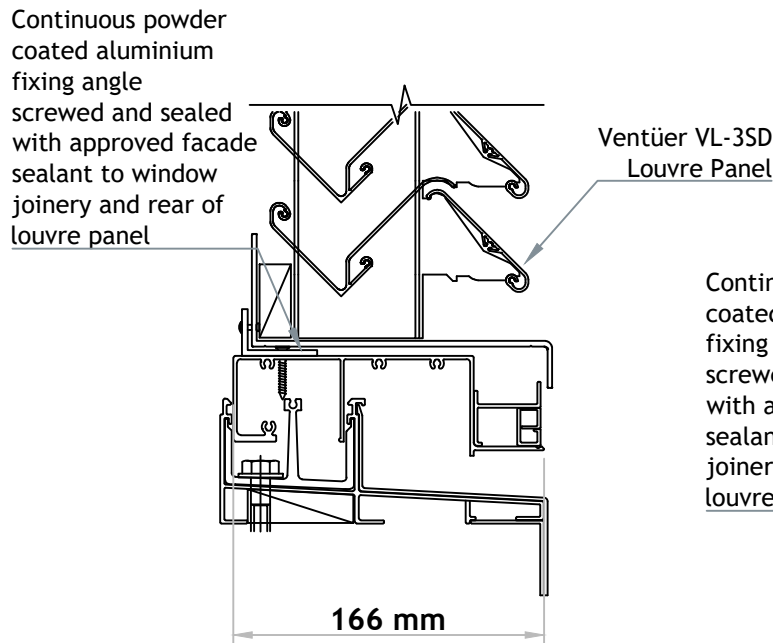

**VL-3SD (FLANGED FRAME)  
SILL DETAIL 03  
SCALE 1 : 4**

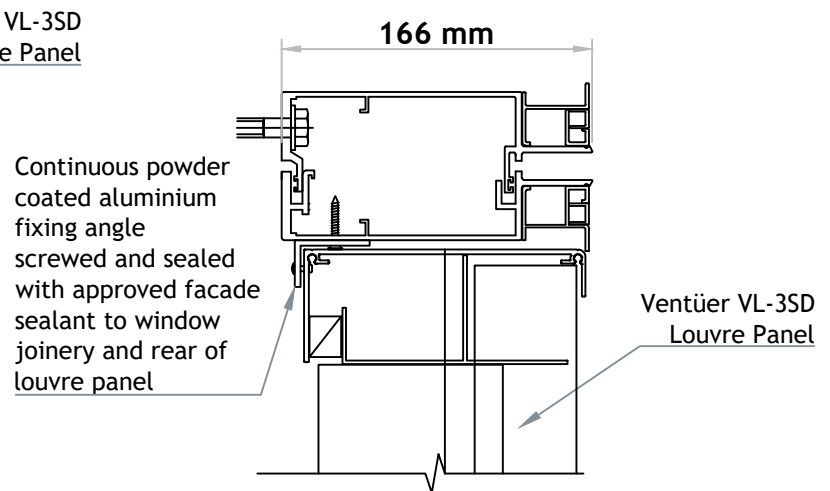

**VL-3SD (FLANGED FRAME)  
JAMB DETAIL 02  
SCALE 1 : 4**

**VENTILATION LOUVRE  
VL-3SD**

FIXING TO WINDOW JOINERY-SCREW FIXED



**VENTÜER**  
High-Performance Building Ventilation

P: +64 9 973 3616  
W: ventuer.co.nz  
© 2019 All rights reserved

Scale: 1 : 4  
Date: 05/04/2019

VL-3SD Ver.1